

Terboinox d.o.o.

EXPORT-IMPORT

Spojnice



Rohrverschraubungen

Pipe fittings

DIN SPOJKE
DIN ROHRVERSCHRAUBUNGEN
DIN PIPE FITTINGS

MATICA
NUTMUTTER
ROUND NUT

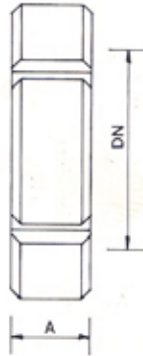

DN	A	B	C	W.Nr.:1.4301/1.4401 AISI 304 / AISI 316
15	20			•
20	20			•
25	21			•
32	21			•
40	21			•
50	22			•
65	25			•
80	30			•
100	31			•

VLOŽEK Z NAVOJEM
ANSCHWEISSGEWINDESTUTZEN
EXPANDING MALE PART

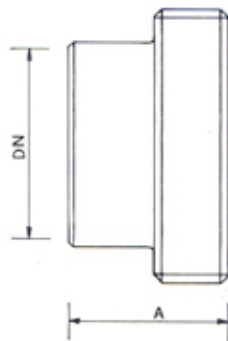

DN	A	B	C	W.Nr.:1.4301/1.4401 AISI 304 / AISI 316
15	24			•
20	24			•
25	29			•
32	32			•
40	33			•
50	35			•
65	40			•
80	44			•
100	53			•

VLOŽEK BREZ NAVOJA
ANSCHWEISSKEGELSTUTZEN
EXPANDING TAPER PART

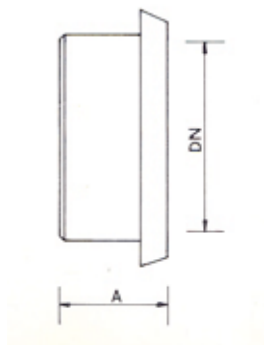

DN	A	B	C	W.Nr.:1.4301/1.4401 AISI 304 / AISI 316
15	20			•
20	20			•
25	21			•
32	25			•
40	26			•
50	28			•
65	32			•
80	35			•
100	42			•

VLOŽEK BREZ NAVOJA S PRIKLJ. ZA GUMI CEV
SCHLAUCHKEGELSTUTZEN
HOSE CONNECTION + TAPER PART EXPANDED

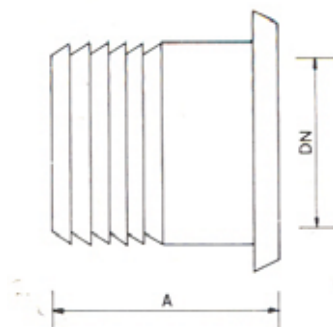

DN	A	B	C	W.Nr.:1.4301/1.4401 AISI 304 / AISI 316
15	50			•
20	55			•
25	62			•
32	65			•
40	75			•
50	90			•
65	100			•
80	120			•
100	120			•

VLOŽEK Z NAVOJEM S PRIKLJUČ

SCHLAUCH GEWINDESTUTZEN

HOSECONNECTION + MALE PART EXPANDED

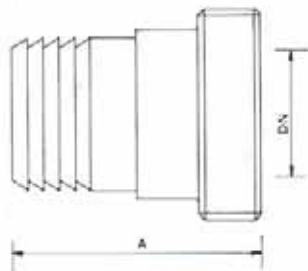

DN	A	B	C	W.Nr.:1.4301/1.4401 AISI 304 / AISI 316
15	55			•
20	60			•
25	67			•
32	70			•
40	80			•
50	95			•
65	105			•
80	125			•
100	125			•

POKROV Z VERIGO

BLINDMUTTER MIT KETTE

BLIND RING WITH CHAIN

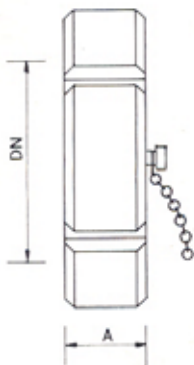

DN	A	B	C	W.Nr.:1.4301/1.4401 AISI 304 / AISI 316
15	20			•
20	20			•
25	21			•
32	21			•
40	21			•
50	22			•
65	25			•
80	30			•
100	31			•

TESNILO
DICHTRING
SEAL RING

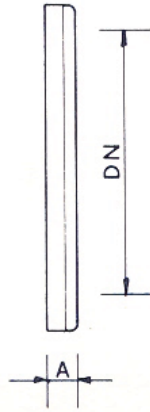

DN	A	B	C	W.Nr.:1.4301/1.4401 AISI 304 / AISI 316
15	4			•
20	4			•
25	5			•
32	5			•
40	5			•
50	5			•
65	5			•
80	5			•
100	5			•